

SuperSOT4™ DUAL 20V NPN SILICON LOW SATURATION SWITCHING TRANSISTOR

SUMMARY

$V_{CE0} = 20V$; $R_{SAT} = 40m\Omega$; $I_C = 3.5A$

DESCRIPTION

This new 4th generation ultra low saturation transistor utilises the Zetex matrix structure combined with advanced assembly techniques to give extremely low on state losses. This makes it ideal for high efficiency, low voltage switching applications.



MSOP8

FEATURES

- Extremely Low Equivalent On Resistance
- Extremely Low Saturation Voltage
- h_{FE} characterised up to 10A
- $I_C = 3.5A$ Continuous Collector Current
- MSOP8 package

APPLICATIONS

- DC - DC Converters
- Power Management Functions
- Power switches
- Motor control

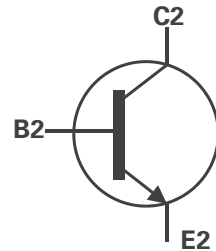
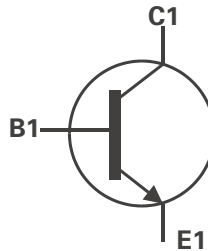

ORDERING INFORMATION

DEVICE	REEL SIZE (inches)	TAPE WIDTH (mm)	QUANTITY PER REEL
ZXT12N20DXTA	7	12mm embossed	1000 units
ZXT12N20DXTC	13	12mm embossed	4000 units

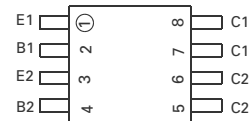

Top View

DEVICE MARKING

T12N20DX

ZXT12N20DX

ABSOLUTE MAXIMUM RATINGS.

PARAMETER	SYMBOL	LIMIT	UNIT
Collector-Base Voltage	V_{CBO}	50	V
Collector-Emitter Voltage	V_{CEO}	20	V
Emitter-Base Voltage	V_{EBO}	7.5	V
Peak Pulse Current	I_{CM}	15	A
Continuous Collector Current	I_C	3.5	A
Base Current	I_B	500	mA
Power Dissipation at $T_A=25^{\circ}\text{C}$ (a)(d) Linear Derating Factor	P_D	0.87 6.9	W mW/ $^{\circ}\text{C}$
Power Dissipation at $T_A=25^{\circ}\text{C}$ (a)(e) Linear Derating Factor	P_D	1.04 8.3	W mW/ $^{\circ}\text{C}$
Power Dissipation at $T_A=25^{\circ}\text{C}$ (b)(d) Linear Derating Factor	P_D	1.25 10	W mW/ $^{\circ}\text{C}$
Operating and Storage Temperature Range	$T_j:T_{stg}$	-55 to +150	$^{\circ}\text{C}$

THERMAL RESISTANCE

PARAMETER	SYMBOL	VALUE	UNIT
Junction to Ambient (a)(d)	$R_{\theta JA}$	143	$^{\circ}\text{C}/\text{W}$
Junction to Ambient (b)(d)	$R_{\theta JA}$	100	$^{\circ}\text{C}/\text{W}$
Junction to Ambient (a)(e)	$R_{\theta JA}$	120	$^{\circ}\text{C}/\text{W}$

NOTES

(a) For a device surface mounted on 25mm x 25mm FR4 PCB with high coverage of single sided 1oz copper, in still air conditions

(b) For a device surface mounted on FR4 PCB measured at $t \leq 5$ secs.

(c) Repetitive rating - pulse width limited by maximum junction temperature. Refer to Transient Thermal Impedance graph.

(d) For device with one active die.

(e) For device with two active die running at equal power.

ZXT12N20DX

CHARACTERISTICS

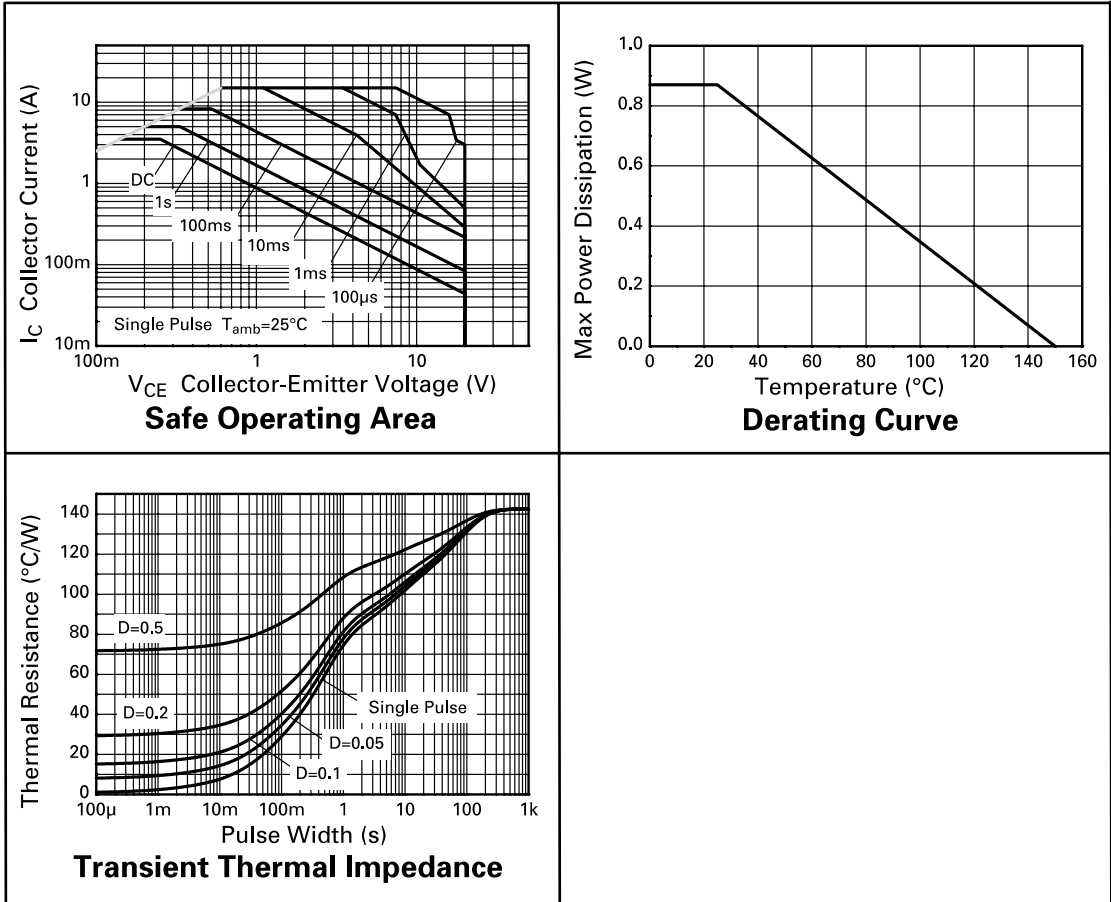

ZXT12N20DX

ELECTRICAL CHARACTERISTICS (at $T_{amb} = 25^{\circ}\text{C}$ unless otherwise stated).

PARAMETER	SYMBOL	MIN.	TYP.	MAX.	UNIT	CONDITIONS.
Collector-Base Breakdown Voltage	$V_{(BR)CBO}$	50	100		V	$I_C=100\mu\text{A}$
Collector-Emitter Breakdown Voltage	$V_{(BR)CEO}$	20	30		V	$I_C=10\text{mA}^*$
Emitter-Base Breakdown Voltage	$V_{(BR)EBO}$	7.5	8.5		V	$I_E=100\mu\text{A}$
Collector Cut-Off Current	I_{CBO}			100	nA	$V_{CB}=40\text{V}$
Emitter Cut-Off Current	I_{EBO}			100	nA	$V_{EB}=6\text{V}$
Collector Emitter Cut-Off Current	I_{CES}			100	nA	$V_{CES}=40\text{V}$
Collector-Emitter Saturation Voltage	$V_{CE(sat)}$		7.0 65 120 160	10 100 160 200	mV mV mV mV	$I_C=0.1\text{A}, I_B=10\text{mA}^*$ $I_C=1\text{A}, I_B=10\text{mA}^*$ $I_C=3\text{A}, I_B=150\text{mA}^*$ $I_C=3.5\text{A}, I_B=50\text{mA}^*$
Base-Emitter Saturation Voltage	$V_{BE(sat)}$		0.9	1.0	V	$I_C=3.5\text{A}, I_B=50\text{mA}^*$
Base-Emitter Turn-On Voltage	$V_{BE(on)}$		0.85	0.9	V	$I_C=3.5\text{A}, V_{CE}=2\text{V}^*$
Static Forward Current Transfer Ratio	h_{FE}	250 300 200 40	400 450 320 70	900		$I_C=10\text{mA}, V_{CE}=2\text{V}^*$ $I_C=1\text{A}, V_{CE}=2\text{V}^*$ $I_C=3.5\text{A}, V_{CE}=2\text{V}^*$ $I_C=10\text{A}, V_{CE}=2\text{V}^*$
Transition Frequency	f_T		112		MHz	$I_C=50\text{mA}, V_{CE}=10\text{V}$ $f=50\text{MHz}$
Output Capacitance	C_{obo}		43		pF	$V_{CB}=10\text{V}, f=1\text{MHz}$
Turn-On Time	$t_{(on)}$		65		ns	$V_{CC}=10\text{V}, I_C=2\text{A}$ $I_{B1}=I_{B2}=40\text{mA}$
Turn-Off Time	$t_{(off)}$		400		ns	

*Measured under pulsed conditions. Pulse width=300 μs . Duty cycle $\leq 2\%$

ZXT12N20DX

TYPICAL CHARACTERISTICS

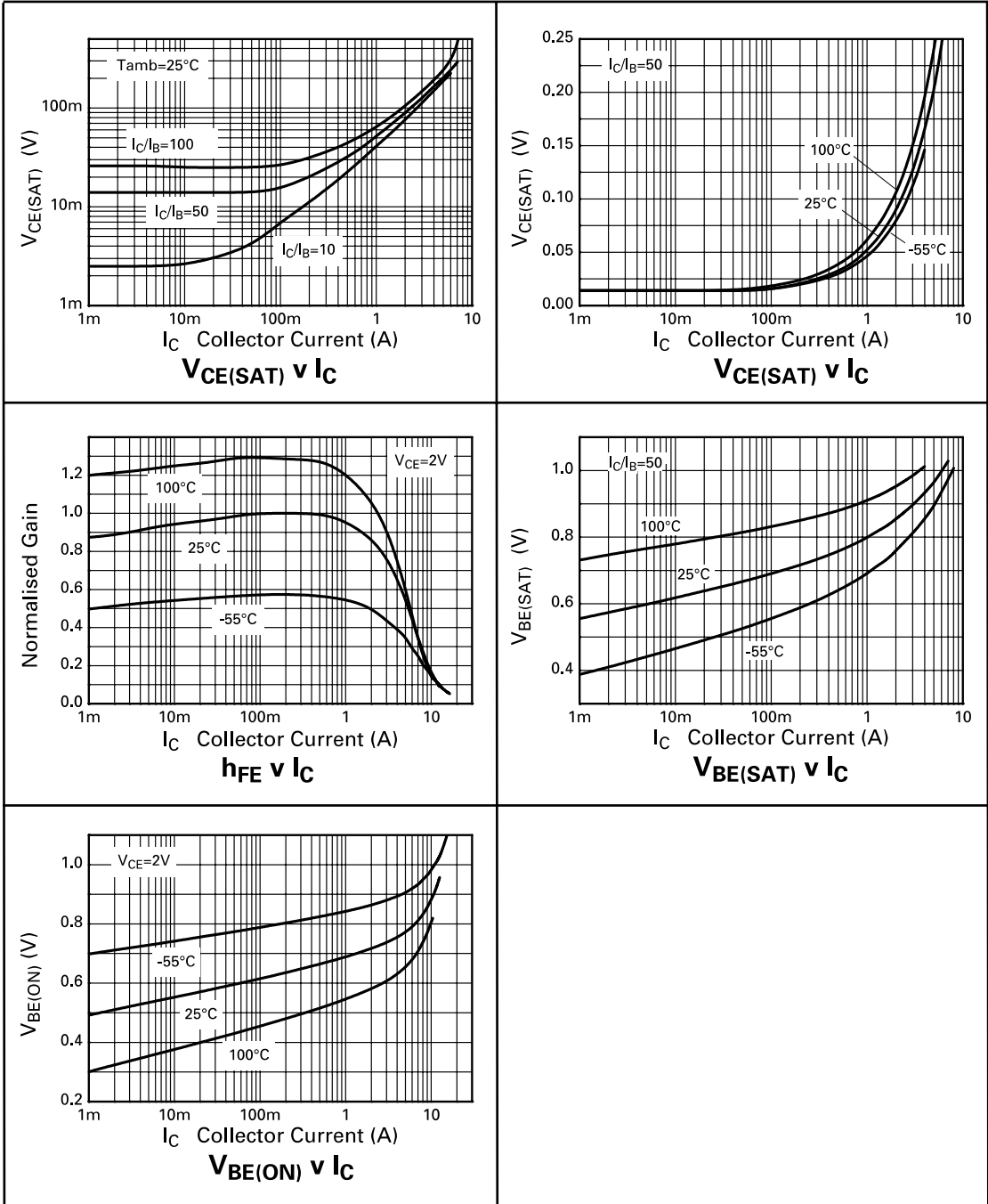

ZXT12N20DX

PACKAGE DIMENSIONS

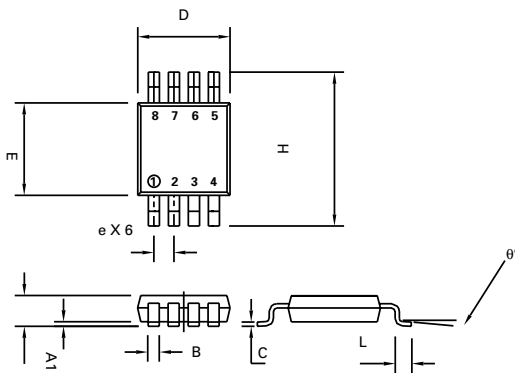

Conforms to JEDEC MO-187 Iss A

PAD LAYOUT DETAILS

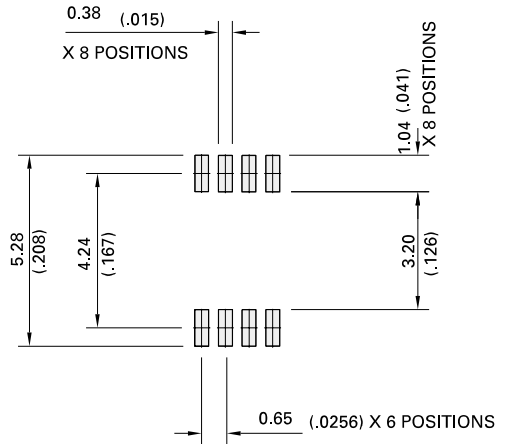

DIM	Millimetres		Inches	
	MIN	MAX	MIN	MAX
A		1.10		0.043
A1	0.05	0.15	0.002	0.006
B	0.25	0.40	0.010	0.016
C	0.13	0.23	0.005	0.009
D	2.90	3.10	0.114	0.122
e	0.65	BSC	0.0256	BSC
E	2.90	3.10	0.114	0.122
H	4.90	BSC	0.193	BSC
L	0.40	0.70	0.016	0.028
q°	0°	6°	0°	6°



Zetex plc.
Fields New Road, Chadderton, Oldham, OL9-8NP, United Kingdom.
Telephone: (44)161 622 4422 (Sales), (44)161 622 4444 (General Enquiries)
Fax: (44)161 622 4420

Zetex GmbH
Streitfeldstraße 19
D-81673 München
Germany
Telefon: (49) 89 45 49 49 0
Fax: (49) 89 45 49 49 49

Zetex Inc.
47 Mall Drive, Unit 4
Commack NY 11725
USA
Telephone: (631) 543-7100
Fax: (631) 864-7630

Zetex (Asia) Ltd.
3510 Metroplaza, Tower 2
Hing Fong Road,
Kwai Fong, Hong Kong
Telephone: (852) 26100 611
Fax: (852) 24250 494

These are supported by
agents and distributors in
major countries world-wide
© Zetex plc 2000

Internet <http://www.zetex.com>

This publication is issued to provide outline information only which (unless agreed by the Company in writing) may not be used, applied or reproduced for any purpose or form part of any order or contract or be regarded as a representation relating to the products or services concerned. The Company reserves the right to alter without notice the specification, design, price or conditions of supply of any product or service.